

PHOTOMETRICS REPORT  
**OVATION**  
F-915VW



# Table of Contents

<b>1. Testing Process .....</b>	<b>1</b>
<b>2. Photometric Reports .....</b>	<b>2</b>
<b>Full Flood, Full Power .....</b>	<b>2</b>
Report Summary .....	2
Overall Measurement .....	2
Beam Details .....	3
Polar Diagrams .....	4
<b>50% Zoom, Full Power .....</b>	<b>5</b>
Report Summary .....	5
Overall Measurement .....	5
Beam Details .....	6
Polar Diagrams .....	7
<b>Full Spot, Full Power .....</b>	<b>8</b>
Report Summary .....	8
Overall Measurement .....	8
Beam Details .....	9
Polar Diagrams .....	10
<b>3. Chromaticity Reports .....</b>	<b>11</b>
<b>3200K .....</b>	<b>11</b>
Report Summary .....	11
Chromaticity .....	12
TM-30-18 Details .....	13
<b>5600K .....</b>	<b>14</b>
Report Summary .....	14
Chromaticity .....	15
TM-30-18 Details .....	16
<b>4. Contact Us .....</b>	<b>17</b>

## Testing Process

### Total Illuminance Measurements

Illuminance is measured using the Viso Systems LabSpion<sup>®</sup>, which takes multiple measurements across a light beam to calculate the total delivered lumens, beam, and field of a product. These values can be described as the empirical output of the product as it projects from the lens or lenses. All photometric data contained in this report are obtained from the actual illuminance of the tested Chauvet light source and are never theoretical values derived from calculations.

### Testing Lab Equipment and Process

The Chauvet headquarters in Sunrise, Florida has a climate- and light-controlled photometric testing laboratory where Chauvet products are analyzed and photometric data are measured using the Viso Systems LabSpion<sup>®</sup> light measurement solution.

This system includes a spectrometer sensor, which measures the precise light and color output of the fixture, and a two-axis goniometer, which rotates the product to allow for multi-angle and multi-directional measurement. The Viso Light Inspector software then collects and summarizes the data. From the data gathered, the software can also measure the beam and field angles, accurate color temperature, color quality, and illuminance at multiple distances. The custom-built, Chauvet-specific template presents this information in the photometric and chromaticity reports that follow.

IES (Illuminating Engineering Society) files, an industry-standard file format, are also generated from each test for easy distribution of photometric data.

Several light meters are also used for specific products or to recheck for precision. Accuracy is verified using one or more of the devices listed below:

- Sekonic SpectroMaster C-700-U
- EXTECH HD450 Datalogging Heavy Duty Light Meter
- Asensetek Essence Lighting Passport

To ensure accurate measurements in every photometric or chromaticity test, Chauvet routinely calibrates the LabSpion<sup>®</sup> system every six months as recommended by Viso Systems.

# Photometric Report

Ovation F-915VW: Full Flood, Full Power

## Report Summary

### Output

Total Lumens: 7246 lm  
Peak Intensity: 9381 cd  
Illuminance @ 5m: 375 lux  
Fixture Efficacy: 26 lm/W

### Optical

Horizontal Beam Angle (50%): 51.1°  
Vertical Beam Angle (50%): 50.7°  
Horizontal Field Angle (10%): 83.8°  
Vertical Field Angle (10%): 83.9°  
Horizontal Cutoff Angle (3%): 97.9°  
Vertical Cutoff Angle (3%): 98°

### Conditions

AC Supply: 118 V, 60 Hz  
Power: 278.27 W  
Current: 2.36 A  
Power Factor: 0.99



This data sheet conforms to American National Standard E1.9 – 2007 (R2017). All data was measured and calculated by a Viso Systems LabSpion Goniometer at the Chauvet PD Optics Laboratory in Sunrise, FL on 1/17/2020 to LM-63-2002 Standards.

## Overall Measurement

Angular Beam Distribution

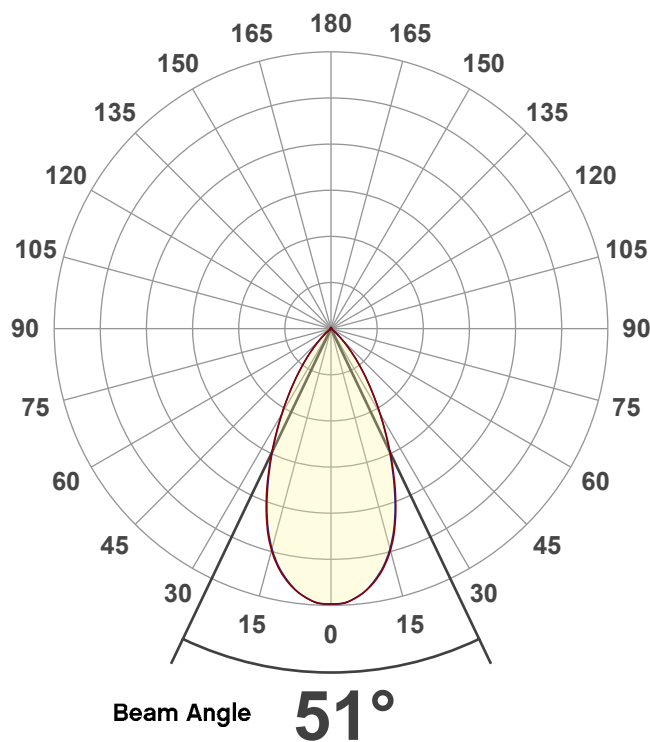

Spectral Distribution

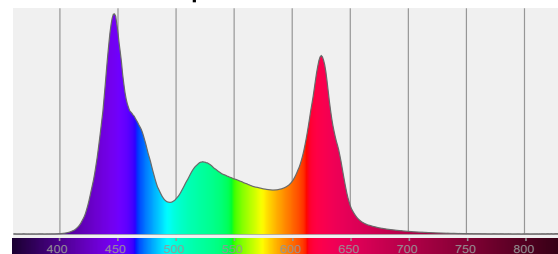

CIE 1931

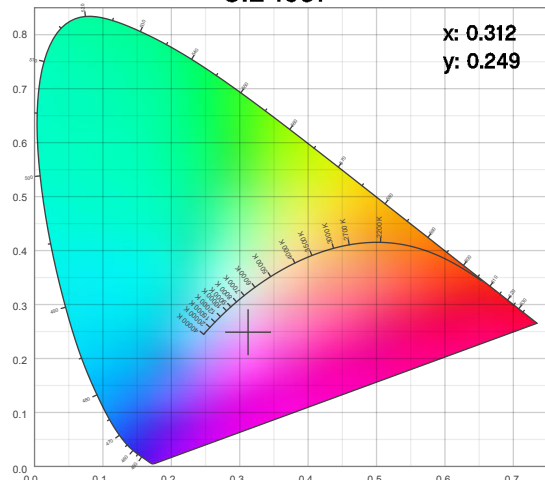

# Photometric Report

Ovation F-915VW: Full Flood, Full Power

## Beam Details

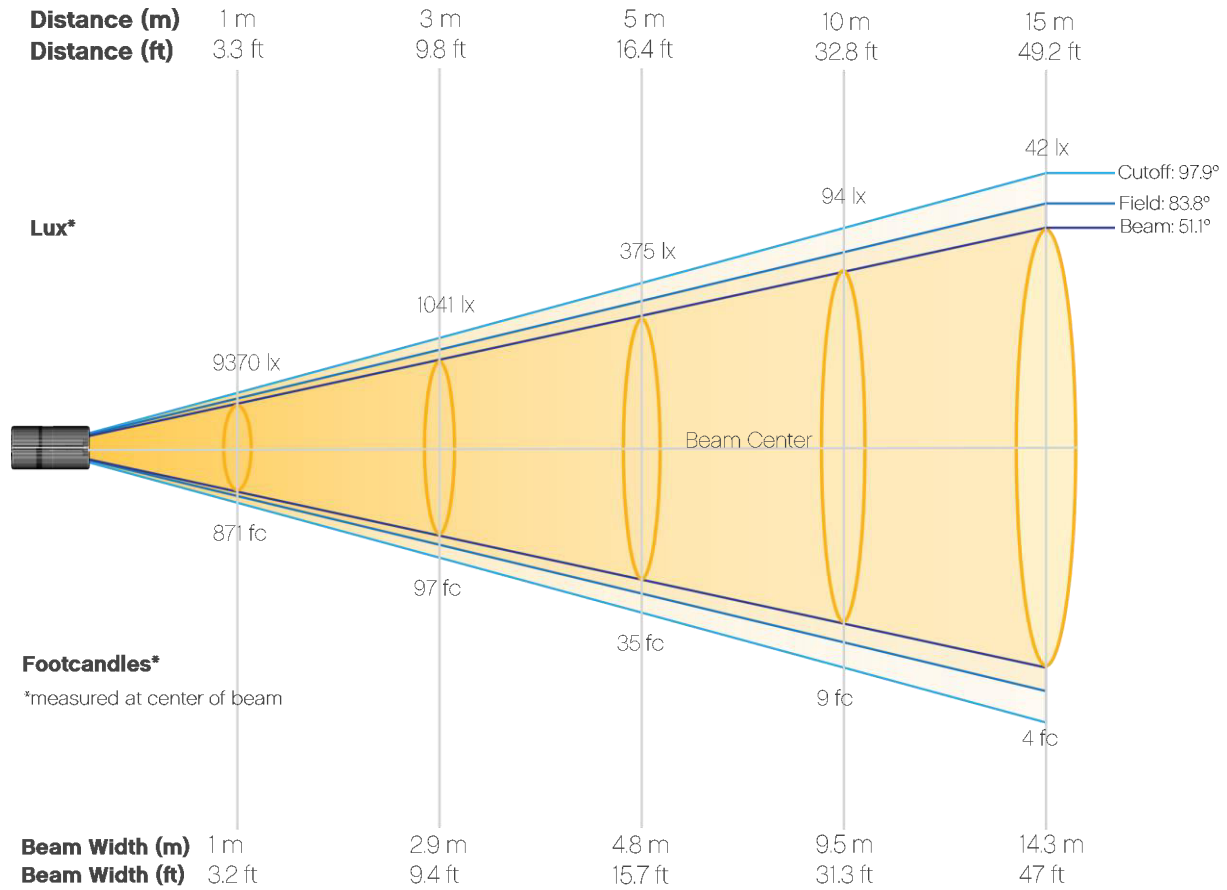

### Beam Illuminances from 1-20m (3.3-65.6ft)

<b>Distance</b>	<b>1m</b>	<b>2m</b>	<b>3m</b>	<b>4m</b>	<b>5m</b>	<b>6m</b>	<b>7m</b>	<b>8m</b>	<b>9m</b>	<b>10m</b>
Lux	9370	2343	1041	586	375	260	191	146	116	94
<b>Distance</b>	<b>11m</b>	<b>12m</b>	<b>13m</b>	<b>14m</b>	<b>15m</b>	<b>16m</b>	<b>17m</b>	<b>18m</b>	<b>19m</b>	<b>20m</b>
Lux	77	65	55	48	42	37	32	29	26	23
<b>Distance</b>	<b>3.3ft</b>	<b>6.6ft</b>	<b>9.8ft</b>	<b>13.1ft</b>	<b>16.4ft</b>	<b>19.7ft</b>	<b>23ft</b>	<b>26.2ft</b>	<b>29.5ft</b>	<b>32.8ft</b>
FC	871	218	97	54	35	24	18	14	11	9
<b>Distance</b>	<b>36.1ft</b>	<b>39.4ft</b>	<b>42.7ft</b>	<b>45.9ft</b>	<b>49.2ft</b>	<b>52.5ft</b>	<b>55.8ft</b>	<b>59.1ft</b>	<b>62.3ft</b>	<b>65.6ft</b>
FC	7	6	5	4	4	3	3	3	2	2

# Photometric Report

Ovation F-915VW: Full Flood, Full Power

## Candela Plot

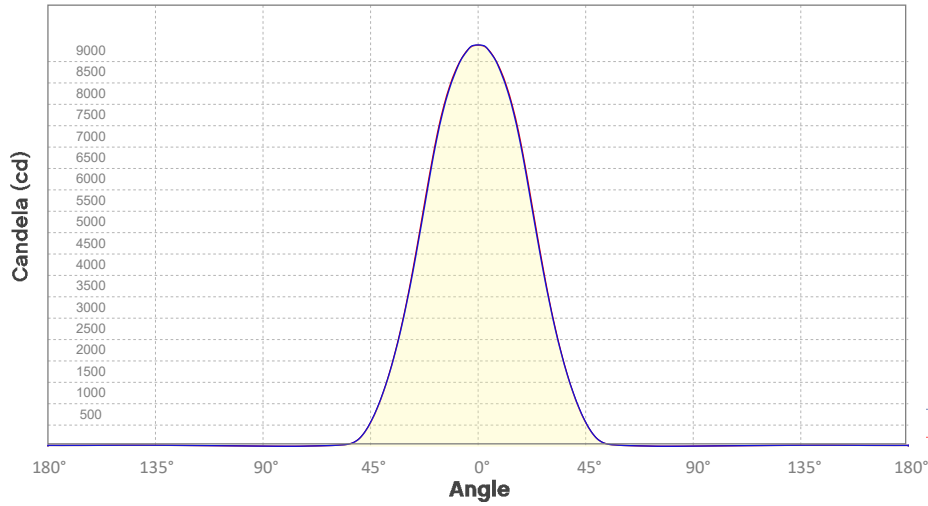

Beam Angle (50%): 51°  
Field Angle (10%): 83.7°  
Cutoff Angle (3%): 98.2°

— Horizontal Distribution  
— Vertical Distribution

## Polar Diagrams

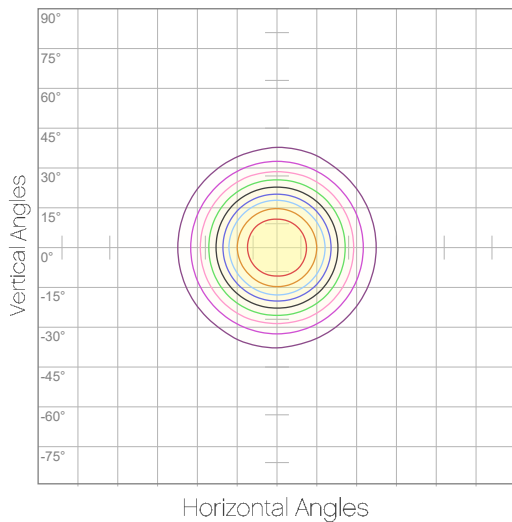

### iso-candela Diagram

10%	937 cd
20%	1874 cd
30%	2811 cd
40%	3748 cd
50%	4685 cd
60%	5622 cd
70%	6559 cd
80%	7496 cd
90%	8433 cd

Conditions:  
Number of c-planes: 8  
Candela at center: 9370 cd

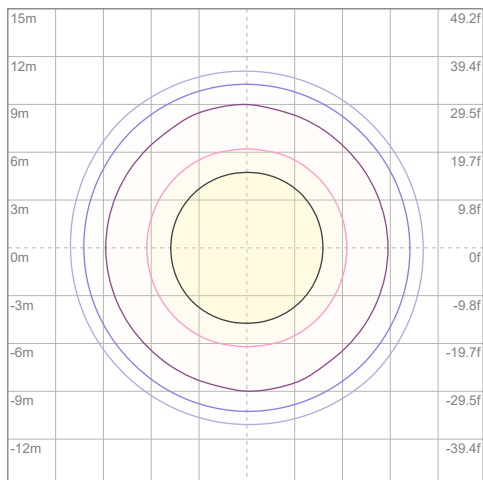

### iso-illuminance Diagram

3%	2.81 lx
5%	4.69 lx
10%	9.37 lx
30%	28.1 lx
50%	46.9 lx

Conditions:  
Number of c-planes: 8  
Lux at center: 93.7 lx

Lux distribution on a surface when lamp is mounted at 10 meters from the surface.

Mounting height: 10 meters / 33 feet

# Photometric Report

Ovation F-915VW: 50% Zoom, Full Power

## Report Summary

### Output

Total Lumens: 6998 lm  
Peak Intensity: 24667 cd  
Illuminance @ 5m: 986 lux  
Fixture Efficacy: 26 lm/W

### Optical

Horizontal Beam Angle (50%): 29.6°  
Vertical Beam Angle (50%): 29.9°  
Horizontal Field Angle (10%): 50.7°  
Vertical Field Angle (10%): 50.4°  
Horizontal Cutoff Angle (3%): 58.3°  
Vertical Cutoff Angle (3%): 58.9°

### Conditions

AC Supply: 118 V, 60 Hz  
Power: 275.57 W  
Current: 2.34 A  
Power Factor: 0.99



This data sheet conforms to American National Standard E1.9 – 2007 (R2017). All data was measured and calculated by a Viso Systems LabSpion Goniometer at the Chauvet PD Optics Laboratory in Sunrise, FL on 1/17/2020 to LM-63-2002 Standards.

## Overall Measurement

Angular Beam Distribution

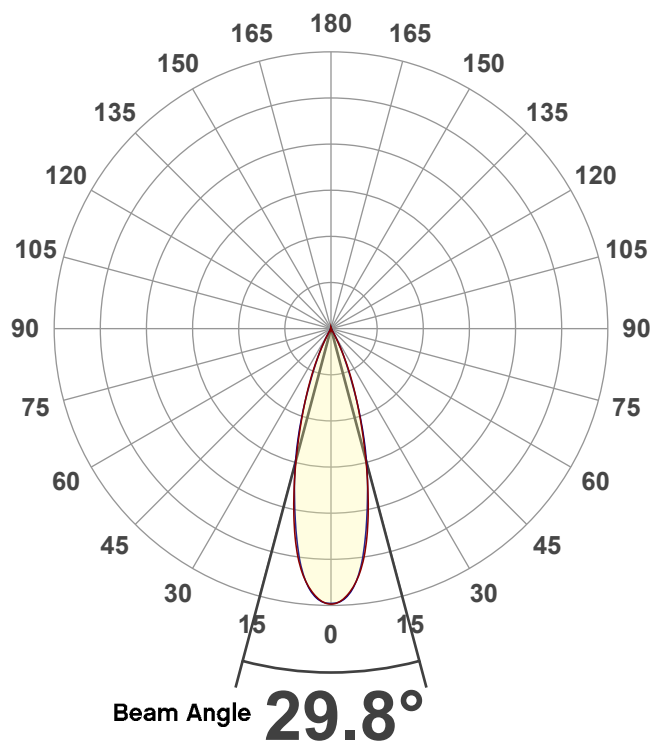

Spectral Distribution

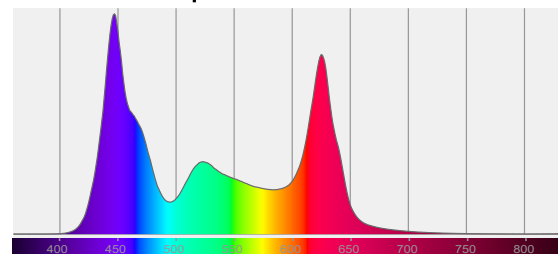

CIE 1931

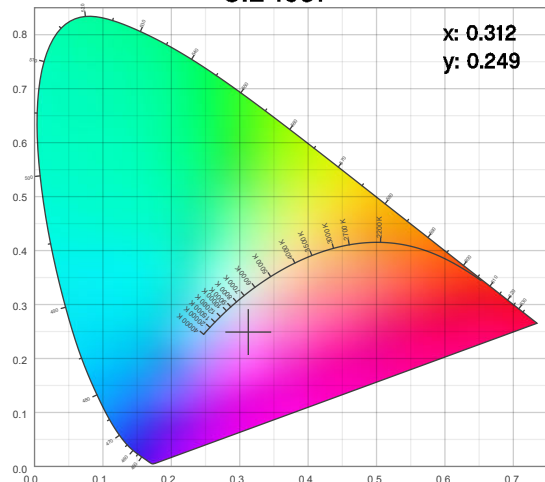

# Photometric Report

Ovation F-915VW: 50% Zoom, Full Power

## Beam Details

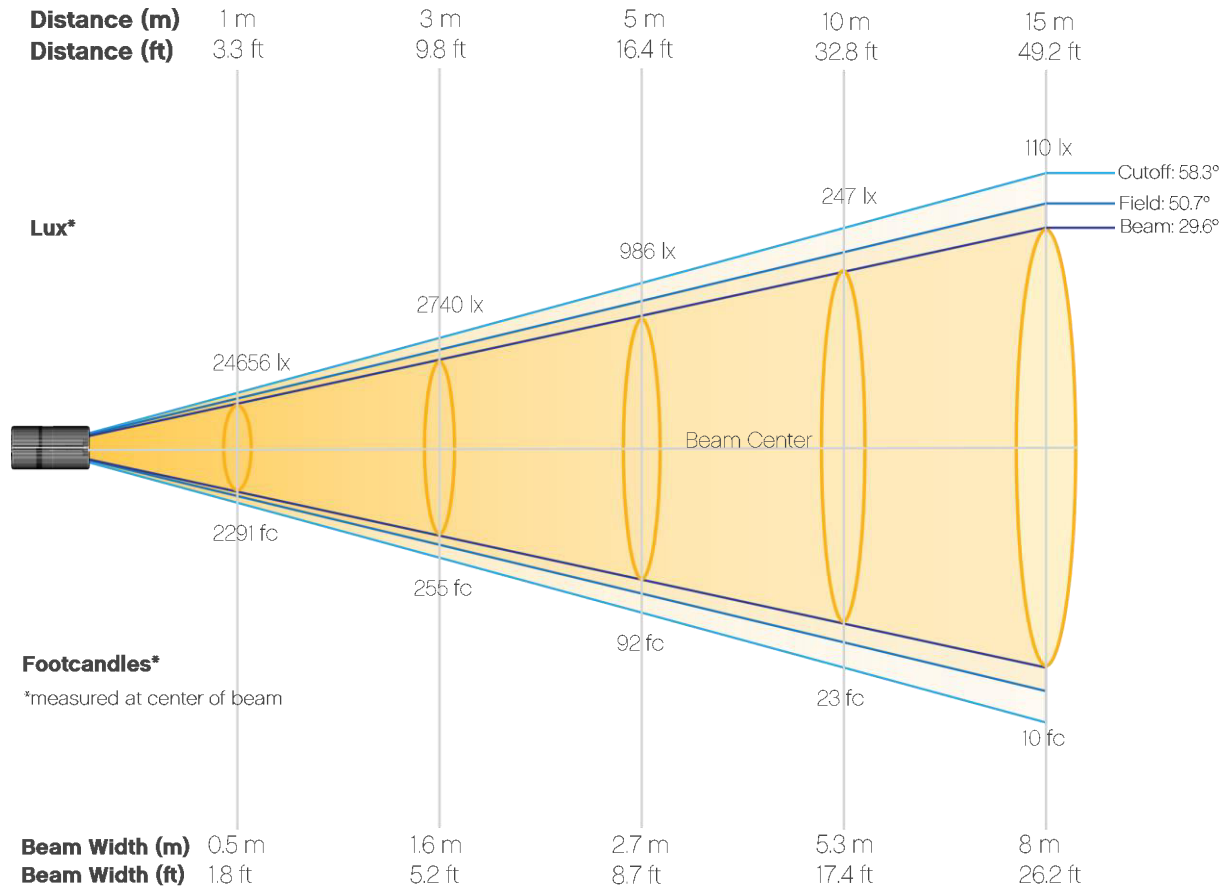

### Beam Illuminances from 1-20m (3.3-65.6ft)

<b>Distance</b>	<b>1m</b>	<b>2m</b>	<b>3m</b>	<b>4m</b>	<b>5m</b>	<b>6m</b>	<b>7m</b>	<b>8m</b>	<b>9m</b>	<b>10m</b>
Lux	24656	6164	2740	1541	986	685	503	385	304	247
<b>Distance</b>	<b>11m</b>	<b>12m</b>	<b>13m</b>	<b>14m</b>	<b>15m</b>	<b>16m</b>	<b>17m</b>	<b>18m</b>	<b>19m</b>	<b>20m</b>
Lux	204	171	146	126	110	96	85	76	68	62
<b>Distance</b>	<b>3.3ft</b>	<b>6.6ft</b>	<b>9.8ft</b>	<b>13.1ft</b>	<b>16.4ft</b>	<b>19.7ft</b>	<b>23ft</b>	<b>26.2ft</b>	<b>29.5ft</b>	<b>32.8ft</b>
FC	2291	573	255	143	92	64	47	36	28	23
<b>Distance</b>	<b>36.1ft</b>	<b>39.4ft</b>	<b>42.7ft</b>	<b>45.9ft</b>	<b>49.2ft</b>	<b>52.5ft</b>	<b>55.8ft</b>	<b>59.1ft</b>	<b>62.3ft</b>	<b>65.6ft</b>
FC	19	16	14	12	10	9	8	7	6	6



# Photometric Report

Ovation F-915VW: 50% Zoom, Full Power

## Candela Plot

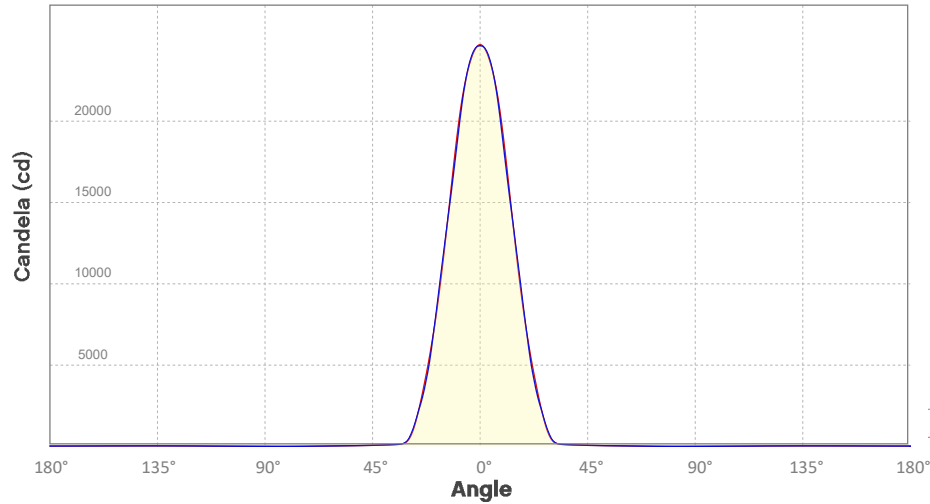

Beam Angle (50%): 29.8°  
Field Angle (10%): 50.6°  
Cutoff Angle (3%): 58.8°

— Horizontal Distribution  
— Vertical Distribution

## Polar Diagrams

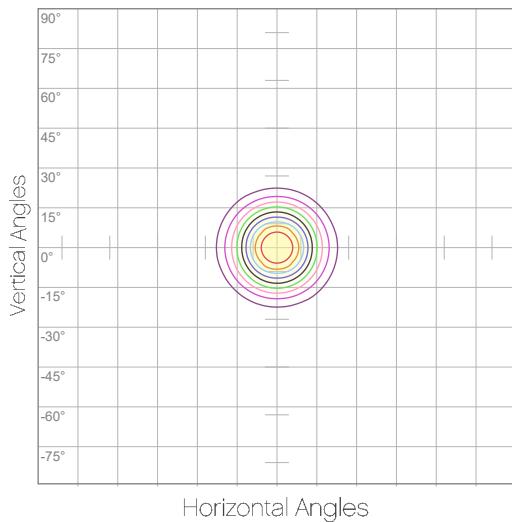

### iso-candela Diagram

10%	2466 cd
20%	4931 cd
30%	7397 cd
40%	9863 cd
50%	12328 cd
60%	14794 cd
70%	17259 cd
80%	19725 cd
90%	22191 cd

Conditions:  
Number of c-planes: 8  
Candela at center: 24656 cd

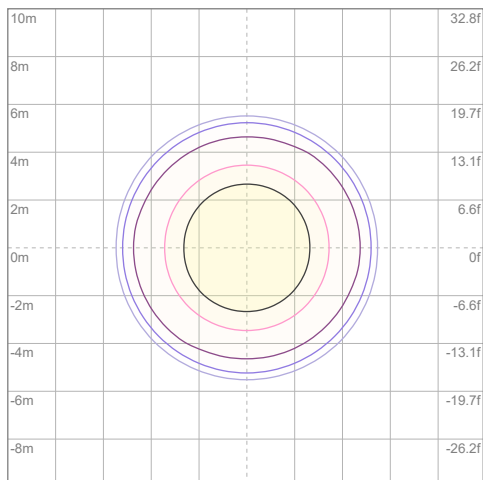

### iso-illuminance Diagram

3%	7.40 lx
5%	12.3 lx
10%	24.7 lx
30%	74.0 lx
50%	123 lx

Conditions:  
Number of c-planes: 8  
Lux at center: 247 lx

Lux distribution on a surface when lamp is mounted at 10 meters from the surface.

Mounting height: 10 meters / 33 feet

# Photometric Report

Ovation F-915VW: Full Spot, Full Power

## Report Summary

### Output

Total Lumens: 4397 lm  
Peak Intensity: 36868 cd  
Illuminance @ 5m: 1473 lux  
Fixture Efficacy: 16 lm/W

### Optical

Horizontal Beam Angle (50%): 18.7°  
Vertical Beam Angle (50%): 18.2°  
Horizontal Field Angle (10%): 32°  
Vertical Field Angle (10%): 31.8°  
Horizontal Cutoff Angle (3%): 39.3°  
Vertical Cutoff Angle (3%): 39.4°

### Conditions

AC Supply: 118 V, 60 Hz  
Power: 280.47 W  
Current: 2.38 A  
Power Factor: 0.99



This data sheet conforms to American National Standard E1.9 – 2007 (R2017). All data was measured and calculated by a Viso Systems LabSpion Goniometer at the Chauvet PD Optics Laboratory in Sunrise, FL on 1/17/2020 to LM-63-2002 Standards.

## Overall Measurement

Angular Beam Distribution

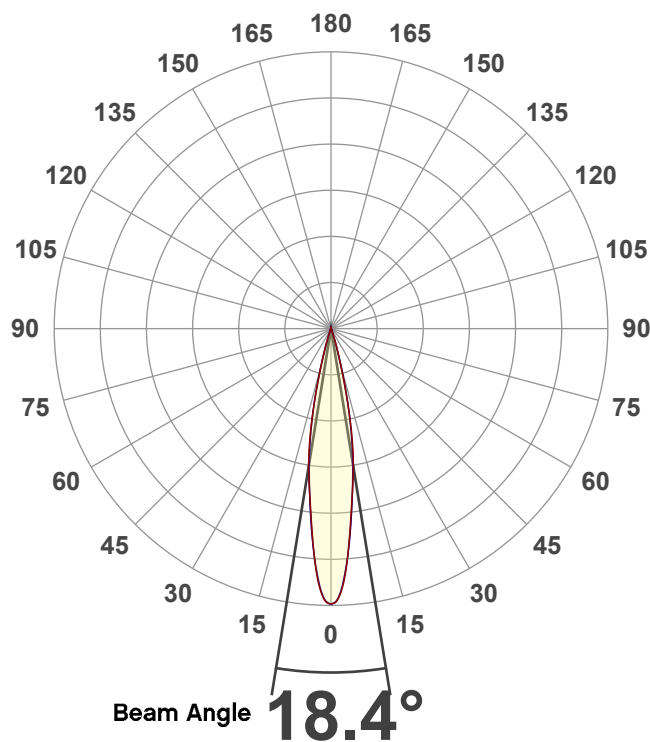

Spectral Distribution

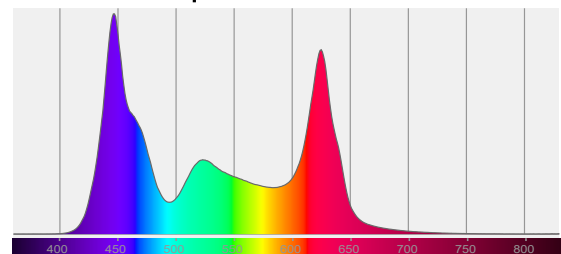

CIE 1931

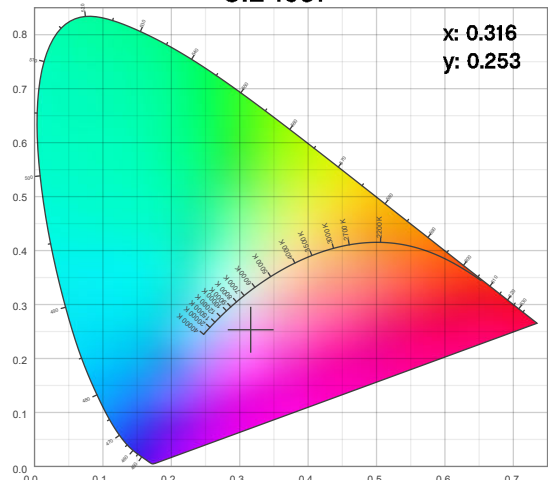

# Photometric Report

Ovation F-915VW: Full Spot, Full Power

## Beam Details

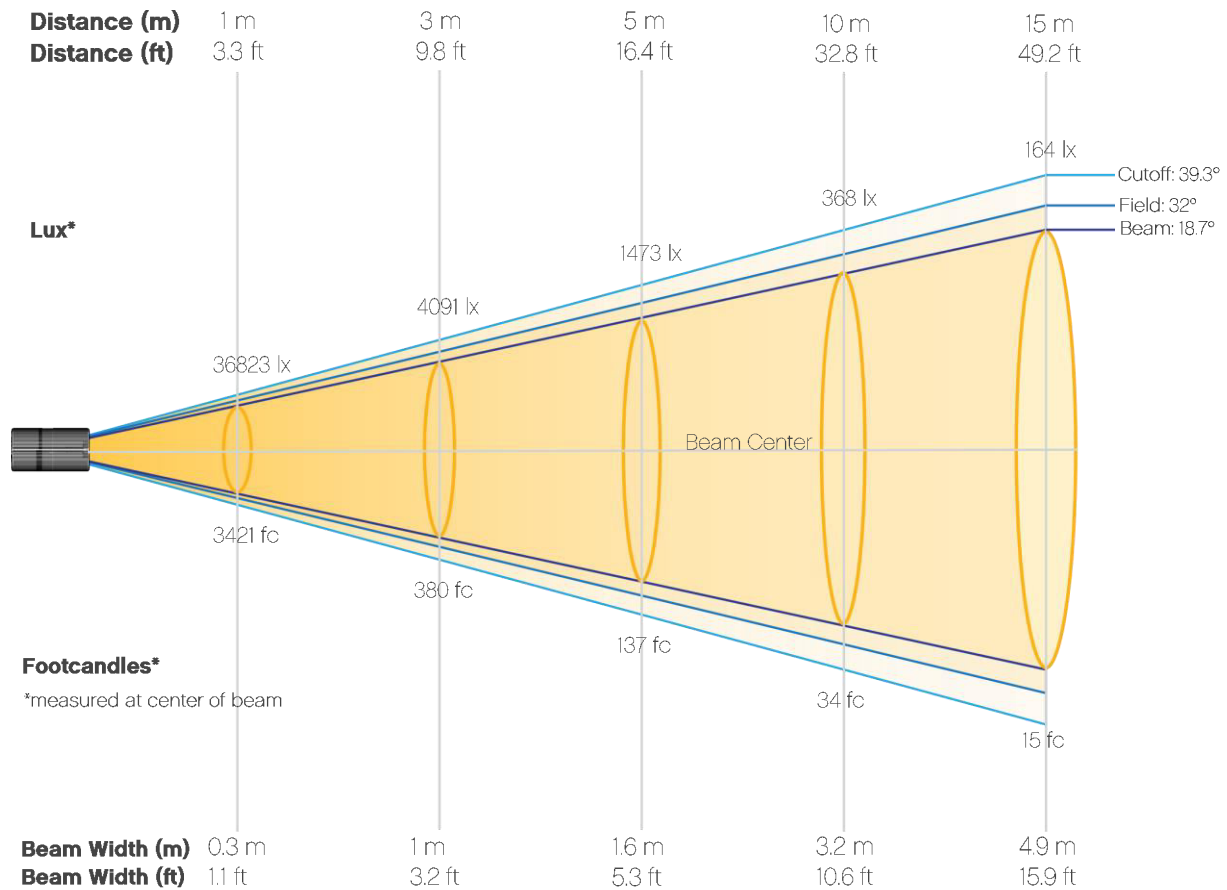

### Beam Illuminances from 1-20m (3.3-65.6ft)

<b>Distance</b>	<b>1m</b>	<b>2m</b>	<b>3m</b>	<b>4m</b>	<b>5m</b>	<b>6m</b>	<b>7m</b>	<b>8m</b>	<b>9m</b>	<b>10m</b>
Lux	36823	9206	4091	2301	1473	1023	751	575	455	368
<b>Distance</b>	<b>11m</b>	<b>12m</b>	<b>13m</b>	<b>14m</b>	<b>15m</b>	<b>16m</b>	<b>17m</b>	<b>18m</b>	<b>19m</b>	<b>20m</b>
Lux	304	256	218	188	164	144	127	114	102	92
<b>Distance</b>	<b>3.3ft</b>	<b>6.6ft</b>	<b>9.8ft</b>	<b>13.1ft</b>	<b>16.4ft</b>	<b>19.7ft</b>	<b>23ft</b>	<b>26.2ft</b>	<b>29.5ft</b>	<b>32.8ft</b>
FC	3421	855	380	214	137	95	70	53	42	34
<b>Distance</b>	<b>36.1ft</b>	<b>39.4ft</b>	<b>42.7ft</b>	<b>45.9ft</b>	<b>49.2ft</b>	<b>52.5ft</b>	<b>55.8ft</b>	<b>59.1ft</b>	<b>62.3ft</b>	<b>65.6ft</b>
FC	28	24	20	17	15	13	12	11	9	9

# Photometric Report

Ovation F-915VW: Full Spot, Full Power  
Candela Plot

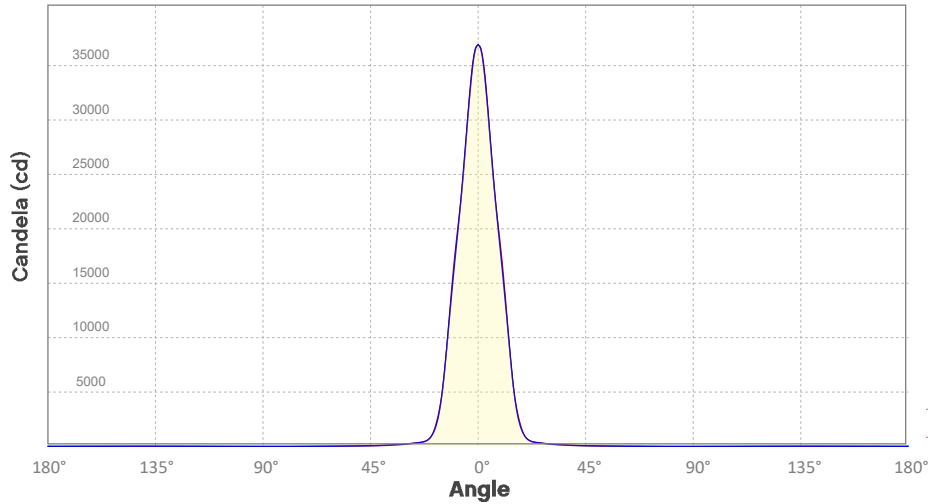

Beam Angle (50%): 18.4°  
Field Angle (10%): 32.1°  
Cutoff Angle (3%): 39.3°

— Horizontal Distribution  
— Vertical Distribution

## Polar Diagrams

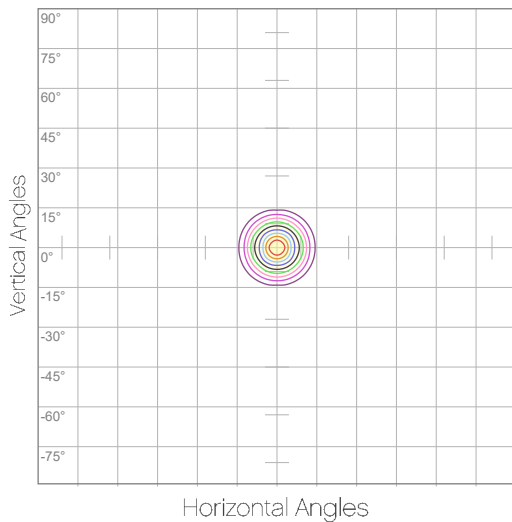

### iso-candela Diagram

10%	3682 cd
20%	7365 cd
30%	11047 cd
40%	14729 cd
50%	18412 cd
60%	22094 cd
70%	25776 cd
80%	29459 cd
90%	33141 cd

Conditions:  
Number of c-planes: 8  
Candela at center: 36823 cd

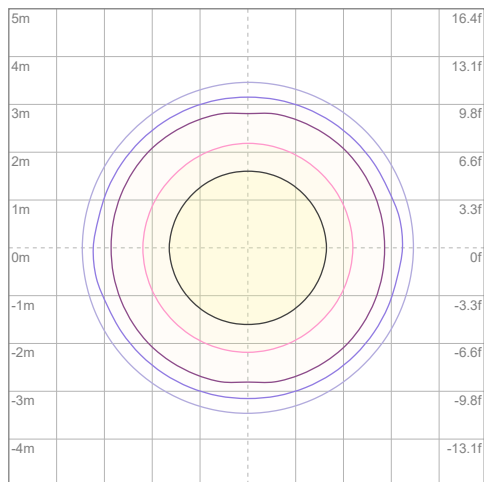

### iso-illuminance Diagram

3%	11.0 lx
5%	18.4 lx
10%	36.8 lx
30%	110 lx
50%	184 lx

Conditions:  
Number of c-planes: 8  
Lux at center: 368 lx

Lux distribution on a surface when lamp is mounted at 10 meters from the surface.

Mounting height: 10 meters / 33 feet

# Chromaticity Report

Ovation F-915VW: 3200K

## Report Summary

### Measurements

Total Lumens: 6753 lm  
Peak Intensity: 23969 cd  
Fixture Efficacy: 33 lm/W

Correlated Color Temperature: 3207K  
 $\Delta uv$ : 0.0014

CRI: 86.7      CRI R9 Value: 81.1  
CQS: 88.7  
TLCI: 76  
TM-30-18 Rf: 88.9  
TM-30-18 Rg: 109.2  
1<sup>st</sup> Dominant Wavelength: 624 nm  
2<sup>nd</sup> Dominant Wavelength: 525 nm



### Spectral Distribution

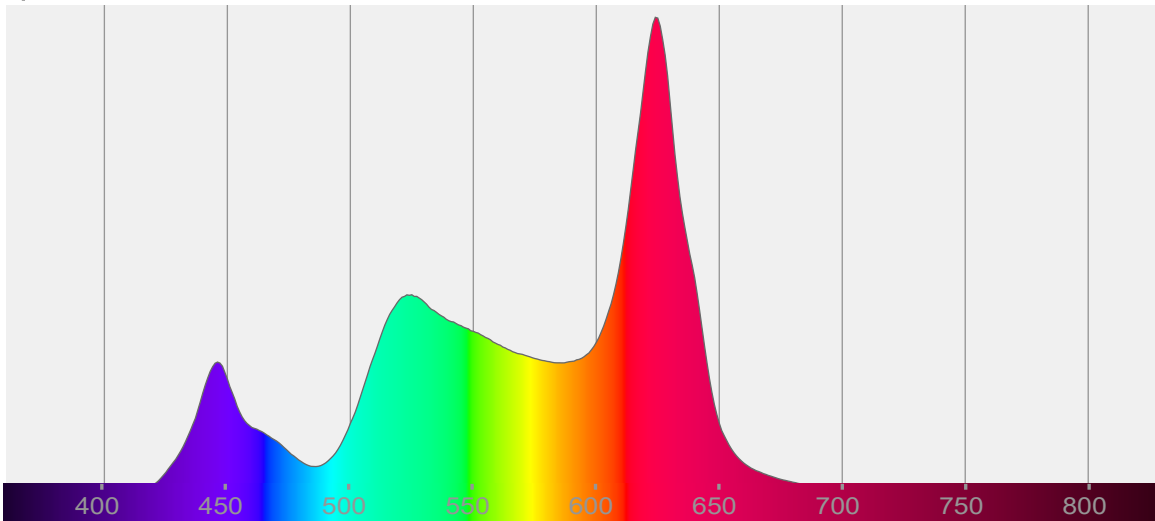

#### Tested Color

**3207 K**  
CIE 1931 Coordinates:  
X: 0.425    Y: 0.403

#### Color Temperature

3207 K

#### Light Quality

CRI: 86.7

#### Notes:

# Chromaticity Report

Ovation F-915VW: 3200K

## Chromaticity

CIE 1931

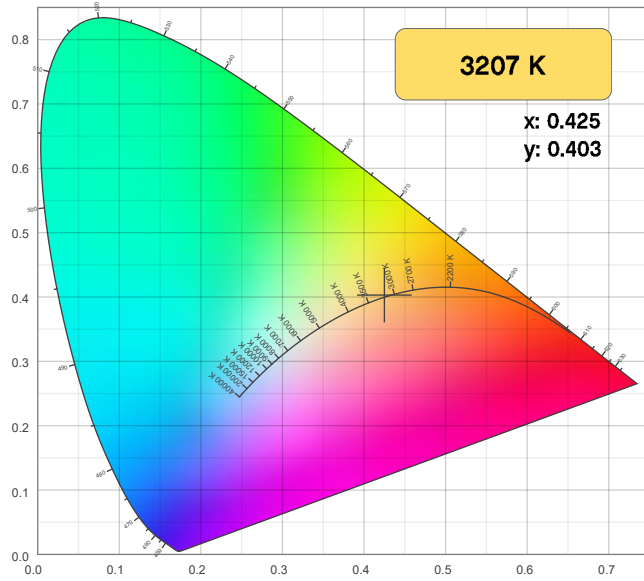

CIE 1931 - Zoom

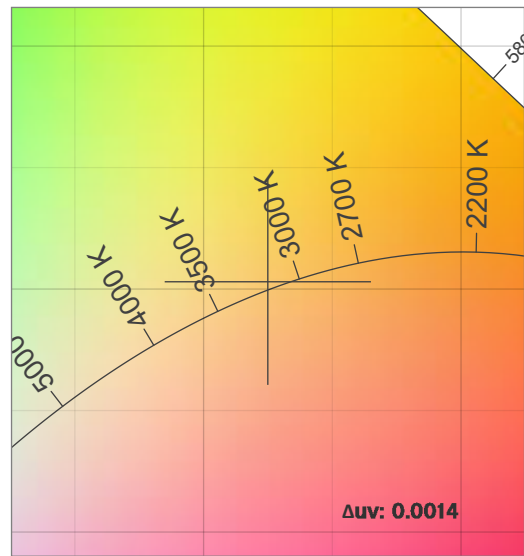

CRI: 86.7 (R1-R8)

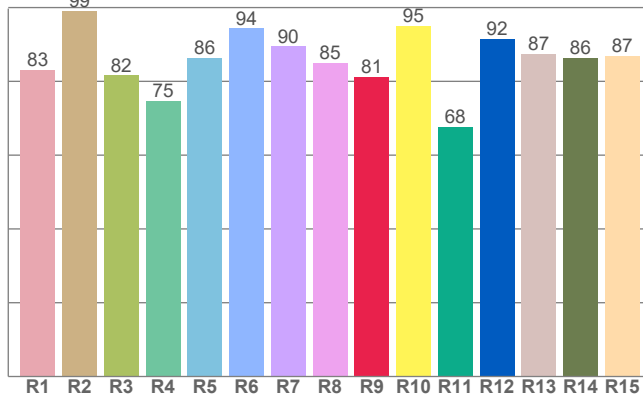

CQS: 88.7

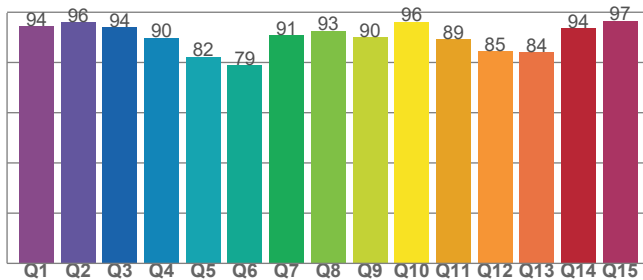

Color Parameters

Color Temperature	Color Coordinate CIE 1931	Color Coordinate CIE 1931
CCT	x	y
3207 K	0.425	0.403

Color Deviation from Black Body Curve	Color Coordinate CIE 1964	Color Coordinate CIE 1964
Δuv	y	u
0.0014	0.403	0.243

Color Rendering Index	Red Component	Color Quality Scale
CRI	CRI - R9	CQS
86.7	81.1	88.7

Television Lighting Consistency Index	Color Fidelity	Color Gamut
TLCI	TM-30-18 - Rf	TM-30-18 Rg
76	88.9	109.2

# Chromaticity Report

Ovation F-915VW: 3200K

## TM-30-18 Details

**Rf 88.9**  
Fidelity Index (R<sub>f</sub>)

**Rg 109.2**  
Gamut Index (R<sub>g</sub>)

Hue Bin	R <sub>f</sub>	Chroma Shift	Hue Shift
1	90	3%	-3%
2	89	4%	-3%
3	90	2%	-2%
4	94	2%	2%
5	89	6%	6%
6	81	11%	7%
7	84	10%	-1%
8	81	11%	-6%
9	87	5%	-7%
10	90	-1%	-6%
11	94	-1%	1%
12	88	4%	-3%
13	90	4%	-5%
14	88	4%	-1%
15	89	5%	0%
16	88	6%	-7%

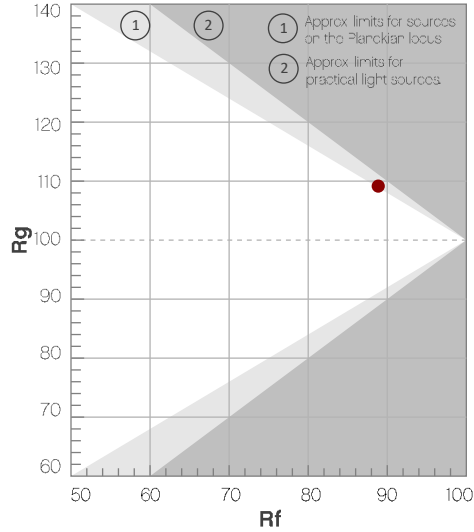

Color Vector Graphic

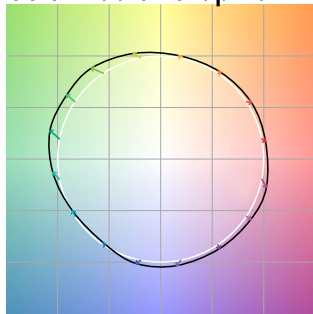

Color Distortion Graphic

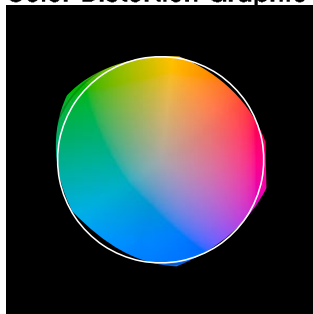

R<sub>f</sub> by Hue Bin

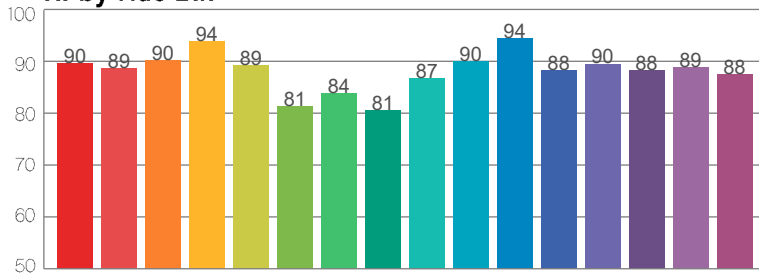

Local Chroma Shift by Hue Bin

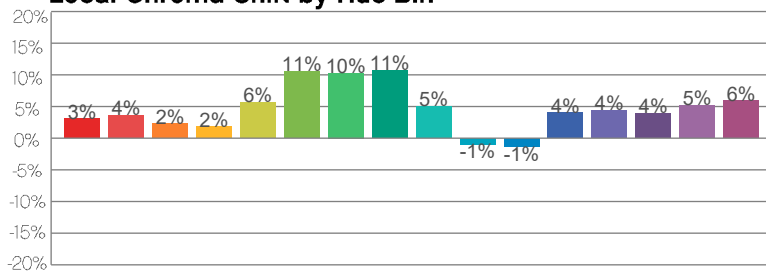

Color Sample Fidelity

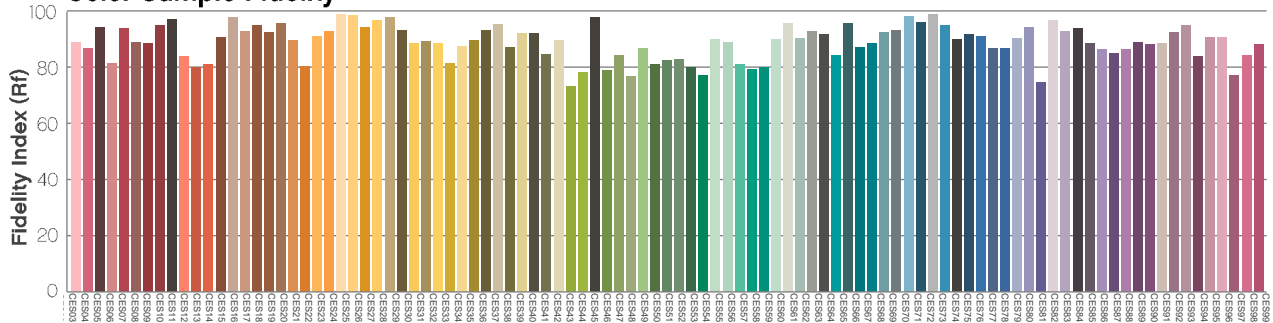

# Chromaticity Report

Ovation F-915VW: 5600K

## Report Summary

### Measurements

Total Lumens: 6436 lm  
Peak Intensity: 22514 cd  
Fixture Efficacy: 32 lm/W

Correlated Color Temperature: 5611K  
 $\Delta uv$ : -0.0083

CRI: 89.5      CRI R9 Value: 85.6  
CQS: 90.2  
TLCI: 88  
TM-30-18 Rf: 88.2  
TM-30-18 Rg: 107.7  
1<sup>st</sup> Dominant Wavelength: 446 nm  
2<sup>nd</sup> Dominant Wavelength: 624 nm



### Spectral Distribution

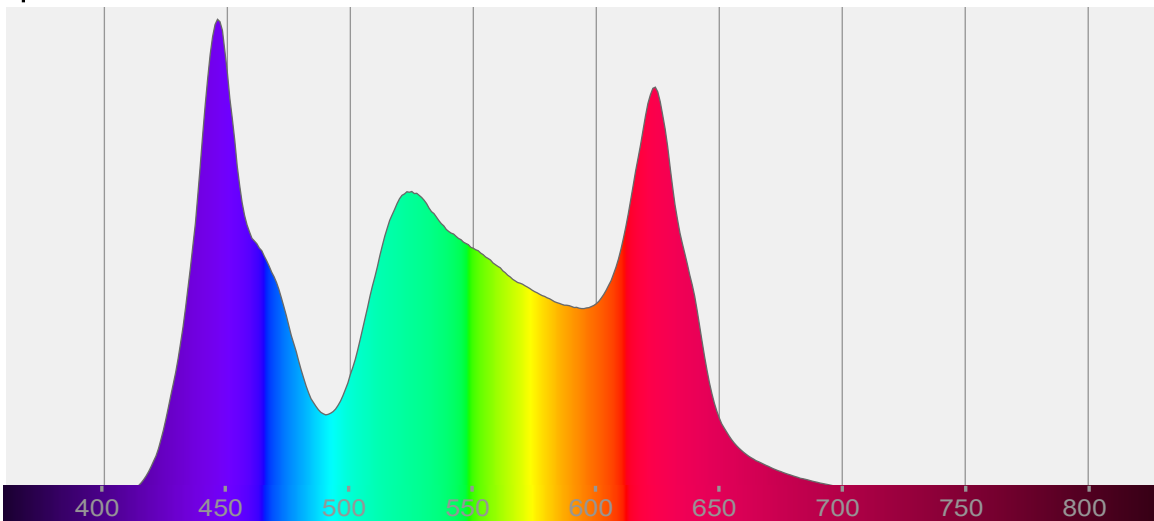

#### Tested Color

5611 K

CIE 1931 Coordinates:  
X: 0.330    Y: 0.330

#### Color Temperature

5611 K

#### Light Quality

CRI: 89.5

#### Notes:



# Chromaticity Report

Ovation F-915VW: 5600K

## Chromaticity

CIE 1931

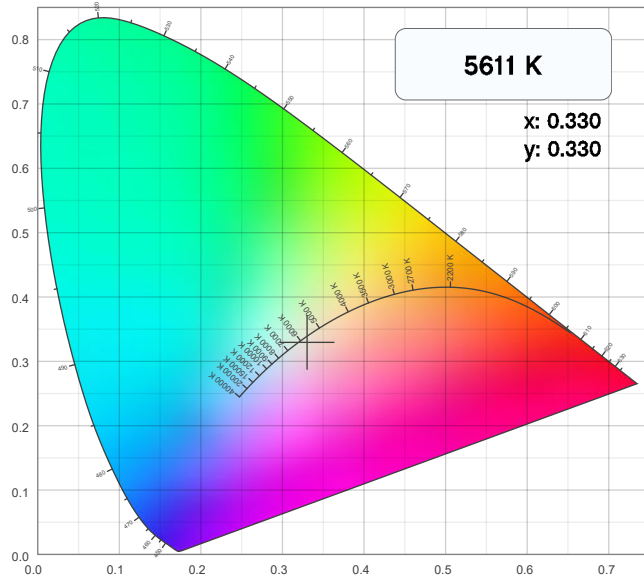

CIE 1931 - Zoom

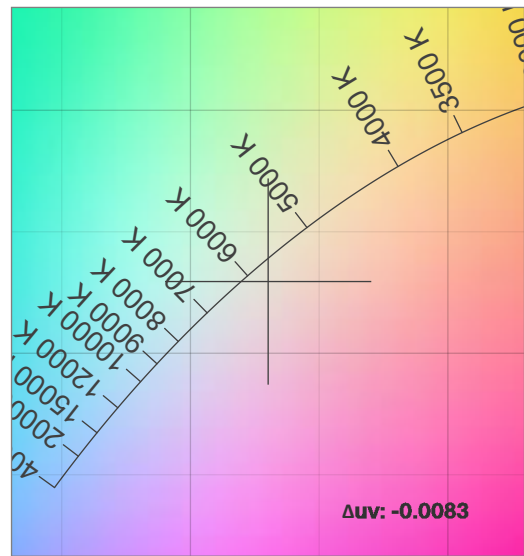

CRI: 89.5 (R1-R8)

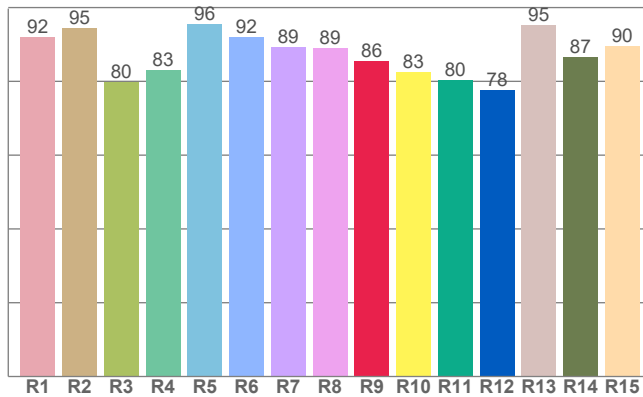

CQS: 90.2

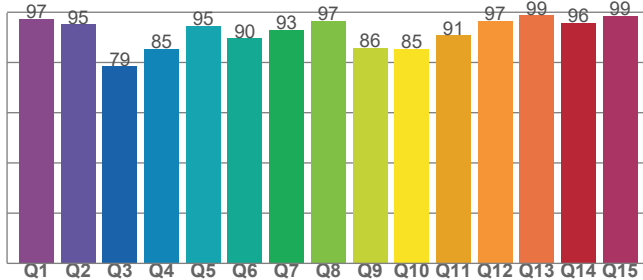

Color Parameters

Color Temperature	Color Coordinate CIE 1931	Color Coordinate CIE 1931
CCT	x	y
5611 K	0.330	0.330

Color Deviation from Black Body Curve	Color Coordinate CIE 1964	Color Coordinate CIE 1964
Δuv	y	u
-0.0083	0.330	0.210

Color Rendering Index	Red Component	Color Quality Scale
CRI	CRI - R9	CQS
89.5	85.6	90.2

Television Lighting Consistency Index	Color Fidelity	Color Gamut
TLCI	TM-30-18 - Rf	TM-30-18 Rg
88	88.2	107.7

# Chromaticity Report

Ovation F-915VW: 5600K

## TM-30-18 Details

**Rf 88.2**  
Fidelity Index (R<sub>f</sub>)

**Rg 107.7**  
Gamut Index (R<sub>g</sub>)

Hue Bin	R <sub>f</sub>	Chroma Shift	Hue Shift
1	93	0%	-1%
2	96	1%	0%
3	90	1%	5%
4	87	2%	8%
5	85	6%	7%
6	85	10%	5%
7	89	7%	-1%
8	93	3%	-2%
9	94	-2%	1%
10	88	-4%	6%
11	79	1%	13%
12	86	3%	9%
13	89	8%	5%
14	83	8%	7%
15	85	12%	-4%
16	90	5%	-2%

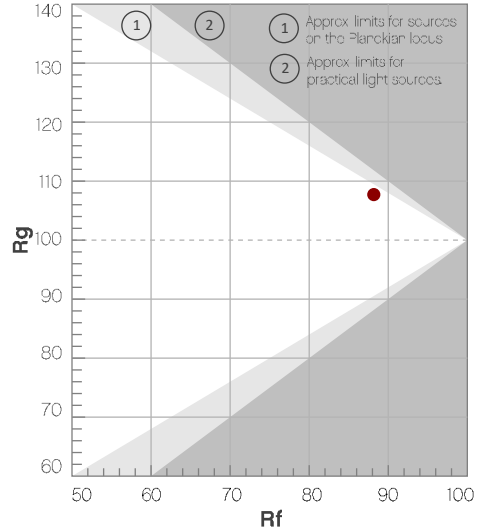

Color Vector Graphic

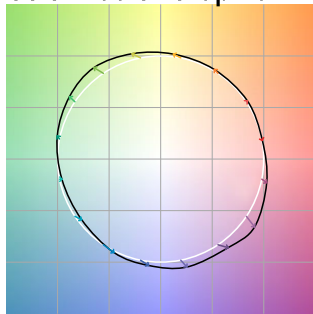

Color Distortion Graphic

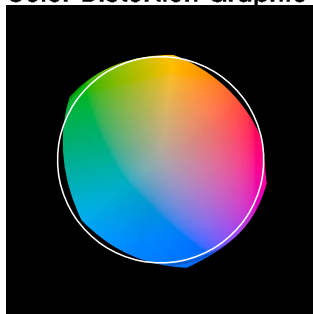

R<sub>f</sub> by Hue Bin

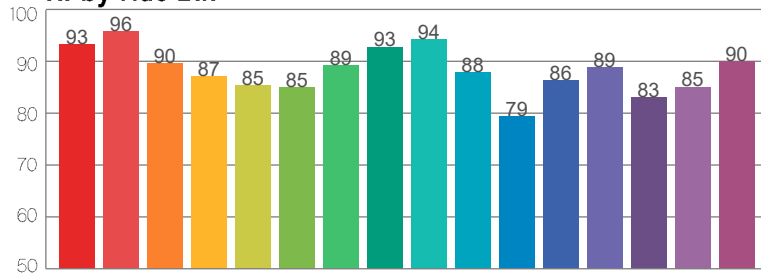

Local Chroma Shift by Hue Bin

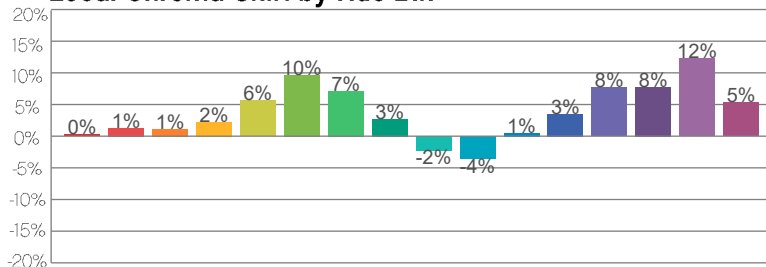

Color Sample Fidelity

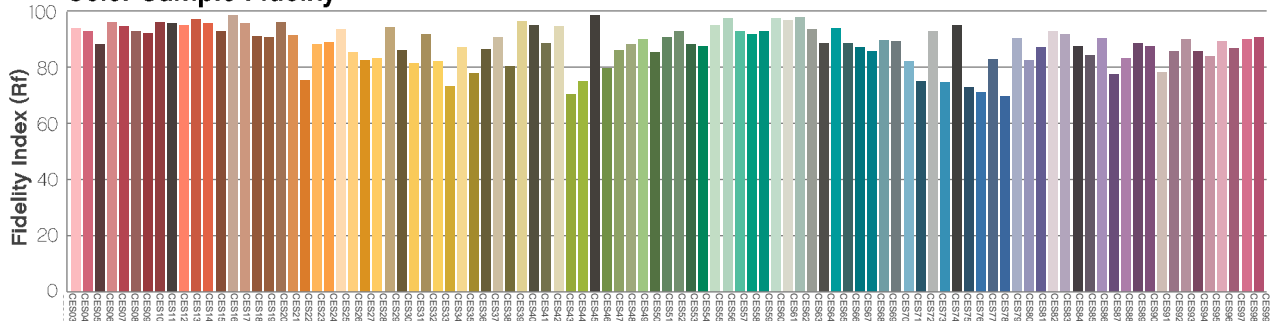

## Contact Us

General Information	Technical Support
<b>Chauvet World Headquarters</b>	
5200 NW 108 <sup>th</sup> Ave. Sunrise, FL 33351 Voice: (954) 577-4455 Fax: (954) 929-5560 Toll Free: (800) 762-1084	Voice: (844) 393-7575 Fax: (954) 756-8015 Email: <a href="mailto:chauvetcs@chauvetlighting.com">chauvetcs@chauvetlighting.com</a> Website: <a href="http://www.chauvetprofessional.com">www.chauvetprofessional.com</a>
<b>Chauvet Europe Ltd</b>	
Unit 1C Brookhill Road Industrial Estate Pinxton, Nottingham, UK NG16 6NT Voice: +44 (0) 1773 511115 Fax: +44 (0) 1773 511110	Email: <a href="mailto:UKtech@chauvetlighting.eu">UKtech@chauvetlighting.eu</a> Website: <a href="http://www.chauvetprofessional.eu">www.chauvetprofessional.eu</a>
<b>Chauvet Europe BVBA</b>	
Stokstraat 18 9770 Kruishoutem, Belgium Voice: +32 (9) 388 93 97	Email: <a href="mailto:BNLtech@chauvetlighting.eu">BNLtech@chauvetlighting.eu</a> Website: <a href="http://www.chauvetprofessional.eu">www.chauvetprofessional.eu</a>
<b>Chauvet France</b>	
3, Rue Ampère 91380 Chilly-Mazarin, France Voice: +33 1 78 85 33 59	Email: <a href="mailto:FRtech@chauvetlighting.fr">FRtech@chauvetlighting.fr</a> Website: <a href="http://www.chauvetprofessional.eu">www.chauvetprofessional.eu</a>
<b>Chauvet Germany</b>	
Bruno-Bürgel-Str. 11 28759 Bremen, Germany Voice: +49 421 62 60 20	Email: <a href="mailto:DEtech@chauvetlighting.de">DEtech@chauvetlighting.de</a> Website: <a href="http://www.chauvetprofessional.eu">www.chauvetprofessional.eu</a>
<b>Chauvet Mexico</b>	
Av. de las Partidas 34 - 3B (Entrance by Calle 2) Zona Industrial Lerma Lerma, Edo. de México, CP 52000 Voice: +52 (728) 690-2010	Email: <a href="mailto:servicio@chauvetlighting.de">servicio@chauvetlighting.de</a> Website: <a href="http://www.chauvetprofessional.eu">www.chauvetprofessional.eu</a>

Visit the applicable website above to verify our contact information and instructions to request support. Outside the U.S., U.K., Ireland, Benelux, France, Germany, or Mexico, contact the dealer of the record.

